

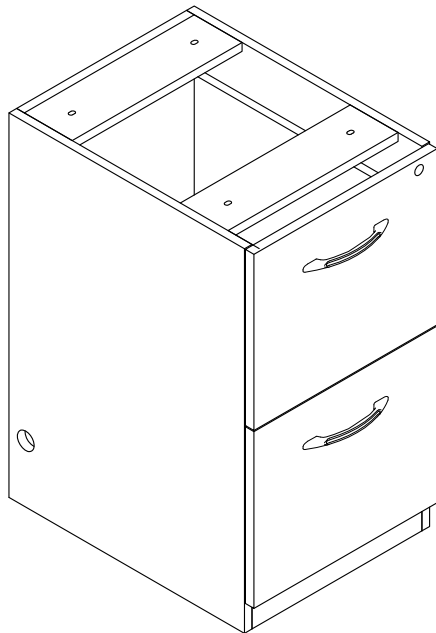

Aberdeen Series™  
 Credenza File/File Pedestal  
 Model No. AFF20

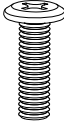
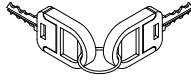

**ASSEMBLY INSTRUCTIONS**  
**CALL 1-800-822-8037 FOR ASSISTANCE**

# PARTS LIST

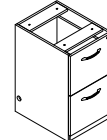
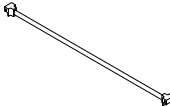
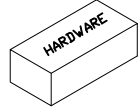
Name	Part	Qty.	Spare Qty	Name	Part	Qty.	Spare Qty
<b>A</b>	 <b>REALS124</b> M6 x 35mm HB	<b>4</b>	<b>1</b>	<b>D</b>	 Keys HB	<b>1</b>	
<b>B</b>	 <b>REALS104</b> Grommet HB	<b>1</b>		<b>E</b>	 <b>AFF20**</b> Pedestal	<b>1</b>	
<b>C</b>	 <b>REALS060</b> 1 Bar w/2 Caps	<b>2</b>					
	 <b>APEDHB</b>						



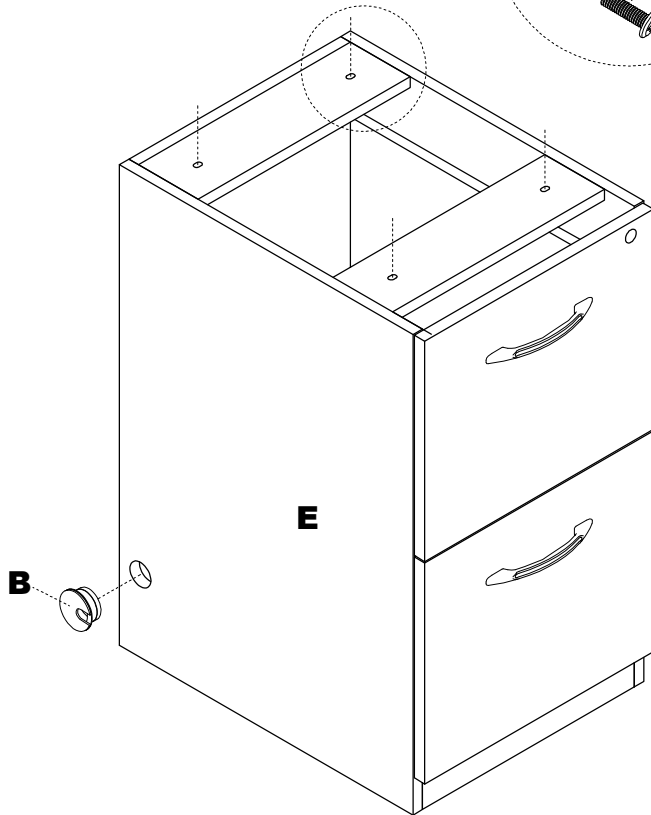
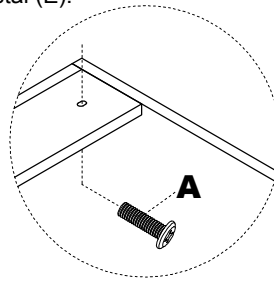

Items with HB are in hardware box.  
 \*\*Denotes Color Code

- 1** Remove drawers and attach Pedestal (E) to underside of Table using Screws (A).  
 - OR -  
 Slide Pedestal (E) under worksurface and adjust levelers as appropriate.
- Insert Grommet (B) in exposed side of Pedestal (E).

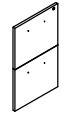
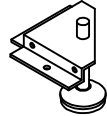

**2**

# Pre-Installed Replacement Parts List

Part	Included Qty.	Part	Included Qty.
 <b>REALS191</b> Handle w/ Screws	<b>2</b>	 <b>AFFDF**</b> Drawer Fronts - Set of 2	<b>1*</b>
 <b>REALS008</b> Corner Bracket w/ Glide	<b>4</b>	 <b>REALS307</b> <sup>A</sup> Drawer Slide 16" - Pair	<b>2</b>
 <b>REALS005</b> Ø4 x 16mm Corner Bracket Screws	<b>24</b>	 <b>REALS121</b> Ø3 x 14mm Drawer Slide Screws	<b>32</b>

\* Available in Cherry (LCR) or Mocha (LDC) finish only.  
 \*\*Denotes Color Code

<sup>A</sup> Previous Drawer Slide Was REALS054. Change effective July 10, 2010

**3**